

TABLE OF CONTENTS

1. INTRODUCTION AND SYSTEM DESCRIPTION	6
2. GLOSSARY	7
3. CONDENSED OPERATING INSTRUCTIONS.....	8
3.1 Power ON	8
3.2 Press Clear.....	8
3.3 Select the Test Mode and press ENTER.....	8
3.4 Program the time(s) and press ENTER.....	9
3.5 Program the current(s) and press ENTER.....	10
3.6 Program the voltages(s) and press ENTER.....	10
3.7 Program additional parameters if applicable to the Mode selected.....	10
3.8 Press VIEW and then MODE to verify what has been programmed	10
3.9 Press VIEW and then TIME, CURRENT, VOLTAGE, or PAR, to verify individually what has been programmed.....	11
3.10 Connect the battery	11
3.11 Press START.....	11
3.12 Press STOP.....	11
3.13 Press RESET	11
4. SPECIFICATIONS.....	12
4.1 CHARGE.....	12
4.2 DISCHARGE	12
4.3 TEST MODES	13
4.4 PROTECTION	13
4.5 ENVIRONMENTAL.....	14
5. CONTROLS AND DISPLAYS	15
5.1 FRONT PANEL – see [Figure 13].....	15
5.2 REAR PANEL see [Figure 14]	17
6. MODES OF OPERATION.....	18
6.1 Parameters Retention.....	18
6.2 Mode 10	18
6.3 Mode 11	18
6.4 Mode 12	18

6.5	Mode 20	18
6.6	Mode 21	19
6.7	Mode 30	19
6.8	Mode 31	19
6.9	Mode 32	19
7.	KEYPAD FUNCTIONS	20
7.1	VIEW:.....	20
7.2	FUNCTION:.....	21
7.3	BATTERY:.....	22
7.4	OPTION:	22
7.5	PARAMETER:	22
8.	OPERATING INSTRUCTIONS.....	23
8.1	GENERAL	23
8.2	PROGRAMMING A BATTERY TEST PROFILE	23
8.3	VIEWING, STORING and RETRIEVING the BATTERY TEST PROFILE	25
8.4	STARTING AND STOPPING OPERATION	26
9.	OPERATING NOTES AND PRECAUTIONS	27
9.1	The negative side of the battery cable is connected to chassis ground. Avoid connecting to other equipment where there may be grounding connection incompatibilities. There could be damage due to high current or current path errors.	27
9.2	Observe Polarity when connecting the charger to a battery or cells.....	27
9.3	Do not start the instrument until a proper connection to a battery or cells has been established.	27
9.4	Do not disconnect the battery cable from the battery while on charge/discharge (severe damage due to arcing may occur).....	27
9.5	The process of discharging batteries generates a considerable amount of heat.	27
9.6	Operation in dusty environment will reduce the cooling efficiency of the discharge banks.	27
10.	INSTALLATION.....	28
10.1	BENCH SPACE	28
10.2	LINE VOLTAGE (mains).....	28
10.3	SYSTEM CONNECTIONS	31
11.	UPDATES	32
11.1	Control Program Update – see [Figure 19] and [Figure 20]	32
11.2	Communications Program Update – see [Figure 21].....	33
12.	VERIFICATION OF PERFORMANCE.....	34
12.1	POWER-UP TESTING.....	34

12.2	KEYPAD and DISPLAY TESTING	35
12.3	Function	39
12.4	Option	40
12.5	POWER TESTS.....	41
12.6	Other	47
13.	CALIBRATION	48
13.1	Reference Illustration	48
13.2	Voltmeter	48
13.3	Ammeter	48
13.4	Charge Current (high).....	49
13.5	Charge Current (low)	49
13.6	Repeat 14.3 and 14.4 as needed.....	49
13.7	Discharge Current (high)	50
13.8	Discharge Current (low).....	50
13.9	Repeat 15.6 and 15.7 as needed.....	50
13.10	Peak Voltage (also applicable to Capacity).....	50
13.11	Constant Voltage.....	51
13.12	Charge Voltage Display.....	51
14.	TROUBLESHOOTING AND REPAIRS	53
14.1	ERROR MESSAGES	53
14.2	TROUBLESHOOTING	55
14.3	FINDING A SHORTED DISCHARGE TRANSISTOR.....	57
15.	POWER BLOCK DIAGRAM.....	60
16.	REPLACEABLE MODULES AND PARTS	61
16.1	Microprocessor Circuit Board – P/N 9879624002.....	61
16.2	Main Circuit Board – P/N 9879624011	61
16.3	Power Control Circuit Board – P/N 9879624004	61
16.4	Relay Control Board – P/N 9879624006	61
16.5	I/O Circuit Board and Harness – P/N 9862603004	61
16.6	Power Supply Cable – P/N 9861603001	61
16.7	Power Feed Cable – P/N 9861603002	61
16.8	Power Supply – P/N 4022PT65A0	61
16.9	Battery Cable, one battery connector – P/N 9895603801	61
16.10	Battery Cable, two battery connector – P/N 9895603802	61
16.11	Relay Control Cable – P/N 9861603004	61
16.12	Discharge Transistor MJ15023 – P/N 4822J15023	61

16.13 Discharge Driver MJ15001 – P/N 4822J15001	61
16.14 Discharge Driver MJ15002 – P/N 4822J15002	61
16.15 SCR Assembly – P/N 9821603401.....	61
16.16 Charge Diode Assembly – P/N 9831603402	61
16.17 Discharge Diode Assembly – P/N 9821603403.....	61
16.18 Battery Cable – P/N 9895603801	61
17. BATTERY TESTING NOTES	62
18. DISCLAIMER.....	63
18.1 This Charger-Analyzer is a precision instrument intended to be operated by personnel qualified in the servicing of aircraft, industrial or medical batteries.....	63
18.2 JFM Engineering’s responsibility is limited to the repair/replacement of any malfunctioning part of the system (not responsible for any losses incurred from the usage of the system).....	63
18.3 User’s Responsibility	63
19. REVISION INDEX.....	64

TABLE OF FIGURES

Figure 1 – Charger-Analyzer Block Diagram..... 6

Figure 2 – Initial Screen 8

Figure 3 – Final Screen..... 8

Figure 4 – Test Mode Screen..... 8

Figure 5 – Number of Batteries 9

Figure 6 – AC Charge Voltage 9

Figure 7 – Time Screen 9

Figure 8 – Time Error Screen 10

Figure 9 – Current Screen..... 10

Figure 10 – Voltage screen 10

Figure 11 – View Test Mode Screen #1 10

Figure 12 – View Test Mode Screen #2 11

Figure 13 – Front view 17

Figure 14 - Rear view 17

Figure 15 - Line Voltage wiring 208/230 29

Figure 16 - Line Voltage Wiring 230/245 29

Figure 17 - Current Limiters..... 30

Figure 18 - Rear Panel Connections 31

Figure 19 - Installed Processor 32

Figure 20 - Processor Sockets..... 32

Figure 21 - Communications Processor Socket 33

Figure 22 – Initial Screen 34

Figure 23 – Final Screen..... 34

Figure 24 – Basic Information Screen 35

Figure 25 – On-Line Status Screen..... 35

Figure 26 – Heatsink Temperature Screen..... 36

Figure 27 – Battery Temperature Screen..... 36

Figure 28 – Ambient Temperature Screen..... 36

Figure 29 – Battery Voltage/Current Screen 36

Figure 30 – Fault Processing Option Screen..... 37

Figure 31 – View Option Screen 37

Figure 32 – Charge Voltage Screen..... 37

Figure 33 – Constant Resistance Screen..... 37

Figure 34 – View Power Voltages Screen 38

Figure 35 – View Backup Battery Screen 38

Figure 36 – Timer Speed Screen 39

Figure 37 – Terminal ID Screen 40

Figure 38 – Number of Batteries Option 40

Figure 39 – View Battery Voltage and Current Screen 43

Figure 40 – View Heat Sink Temperatures Screen..... 45

Figure 41 – Power Fail Screen..... 47

Figure 42 – Power Fail Screen #1..... 47

Figure 43 – Power Fail Screen #2..... 47

Figure 44 - Main Board with Numbered Adjustments 49

Figure 45 - Charge AC inputs..... 51

Figure 46 – Power Control Board Charge Voltage Display Adjust..... 52

Figure 47 - Open resistor measurement..... 58

Figure 48 - Open Resistor measurement..... 59

TABLE OF TABLES

Table 1 - Index of Revisions..... 64

2. GLOSSARY

- **Battery Manual:** General Technical information provided by a manufacturer applicable to a series of batteries.
- **Battery Test Profile:** A specific group of parameters for a specific type of test (e.g., Time, Current and Voltage for a Capacity Test).
- **BTAS16:** A computerized Battery Test System
- **Capacity Test:** Test performed to determine if a battery can deliver the advertised, specified or required amount of current.
- **CMM:** Technical information provided by a manufacturer for a specific battery (Component Maintenance Manual)
- **CPU:** Central Processor Unit that under program control, processes commands to govern and monitor the operation of the instrument
- **C-SCAN:** A Data Acquisition Terminal (part of the BTAS16)
- **Deep Cycle:** As applicable to Nickel-Cadmium batteries, the process of discharge to zero for each of the cells (to equalize the cells).
- **Electrolyte Level Test:** As applied to Nickel-Cadmium cells that have a vent cap, the process of verifying the level of the electrolyte and the addition of distilled water as required (Note that this test is performed only at the end of a charge cycle).
- **Full Discharge:** Constant Current Discharge with no voltage limit (discharge to 0V).
- **Lead-Acid:** Chemistry system of batteries used for most stand-by applications and for applications demanding less severe discharge currents (as compared with Nickel-Cadmium).
- **Main Charge:** As applicable to Nickel-Cadmium batteries, the C/2 charge current that provides 100% of the A-hr rating
- **Nickel-Cadmium:** Chemistry system of batteries as used in aviation and other heavy duty applications.
- **Non-Volatile Memory:** Memory area in the microprocessor where certain options can be stored that will remain even if the power is turned off.
- **Overhaul:** The process of disassembly of all interconnections, cleaning/replacement of interconnecting hardware, removal of cells and cleaning of cells and the interior of the battery. As applied to batteries that are made up from an interconnection of multiple cells.
- **SLA:** Sealed Lead-Acid Battery
- **Temp-Plate:** A plate used to measure the temperature of batteries under test
- **Thermal Runaway:** Destructive condition under constant voltage charging where one cell fails and heats up and causes all other cells to fail by transmission of heat from one cell to the next. The drop in internal voltage causes an increase in charge current that intensifies the heating, thus accelerating the process.
- **Topping Charge:** As applicable to Nickel-Cadmium batteries, the C/10 charge current that provides 40% of the A-hr rating (after the Main Charge)
- **VRLA:** Valve Regulated Lead-Acid Battery

3. CONDENSED OPERATING INSTRUCTIONS

CAUTION: *Disconnect power and batteries before performing any internal maintenance. Failure to observe this caution may result in serious damage to the unit and injury to the operator.*

3.1 Power ON

3.1.1. Turn Main Power ON with the breaker in the Front Panel

3.1.2. Wait for the power-up cycle to be completed (long beep)

3.1.2.1. Initial Screen

```
JFM Engineering, Inc.  
BID=6    TID=0  
24U-1462 18 AUG 2010  
*****
```

Figure 2 – Initial Screen

3.1.2.2. Final Screen

```
T0 M0 00:00:00 N0  
  
Backup Batt=10.00V  
Charge Voltage=40V
```

Figure 3 – Final Screen

3.2 Press Clear

3.3 Select the Test Mode and press ENTER

```
T0 M0 00:00:00 N0  
  
Test Mode #: __
```

Figure 4 – Test Mode Screen

3.3.1. See available Test Modes in [6]

3.3.2. If any of the Charge Modes is selected, Select the Number of Batteries (1 or 2) using Option 3 (if not automatically selected – see 12.4.3):

```
T0 M10 00:00:00 N0  
  
Number of Batteries  
OPTION VALUE: __
```

Figure 5 – Number of Batteries

- Enter 0 for none (charge transformers off)
- Enter 1 for one battery (or combination of batteries up to a total of 22 cells)
- Enter 2 for one battery (or combination of batteries totaling over 22 cells)
- The number will appear on the right hand corner of the LCD display as N0, N1 or N2
- The program will display a message in case the N setting is inconsistent with the programmed voltage or measured battery voltage.
- Note: after changing the number of batteries, the program will display the available charge voltage.

```
T0 M10 00:00:00 N1  
  
Checking AC Voltage  
Charge Voltage=36V
```

Figure 6 – AC Charge Voltage

3.4 Program the time(s) and press ENTER

```
T0 M10 00:00:00 N1  
  
Time: __:__
```

Figure 7 – Time Screen

- 3.4.1. Attempting to enter an inconsistent time (e.g., 01:60) will result in an error message**

```
T0 M10 00:00:00 N1  
  
TIME ENTRY ERROR __:__
```

Figure 8 – Time Error Screen

- 3.5 Program the current(s) and press ENTER**

```
T0 M10 00:00:00 N1  
  
Current: __. __
```

Figure 9 – Current Screen

- 3.6 Program the voltages(s) and press ENTER**

```
T0 M10 00:00:00 N1  
  
Voltage: __. __
```

Figure 10 – Voltage screen

- 3.7 Program additional parameters if applicable to the Mode selected**

(e.g., Resistance value for the Constant Resistance Capacity Test)

- 3.8 Press VIEW and then MODE to verify what has been programmed**

The example shown is for Test Mode 10, one hour, 20A and 0V

```
T0 M0 00:00:00 N1  
  
Test Mode - 10  
T=01:00
```

Figure 11 – View Test Mode Screen #1

T0	M0	00:00:00	N1
V=00.00			
C=020.0			

Figure 12 – View Test Mode Screen #2

3.9 Press VIEW and then TIME, CURRENT, VOLTAGE, or PAR, to verify individually what has been programmed

3.10 Connect the battery

- 3.10.1. Observe Polarity if using clips!
- 3.10.2. If testing only one battery, connect the unused plug to the shorted receptacle in the Temp-plate
- 3.10.3. Verify the battery voltage reading in the voltmeter

3.11 Press START

- 3.11.1. Verify that the timer speed is consistent with the required operation. Use FUNC(TION) 0 to change the Timer Speed: 1 for Normal (HH:MM) and 0 for FAST (MM:SS).
- 3.11.2. Verify that the current starts at a low value and reaches the programmed level in several seconds (the actual time to reach full current depends on the programmed value)
- 3.11.3. Verify that the battery voltage changes in accordance with the mode selected (the result of current flowing into or out of the battery).

3.12 Press STOP

- 3.12.1. Press STOP to halt the operation
- 3.12.2. Re-program parameters if required
- 3.12.3. Press START to resume operation

3.13 Press RESET

- 3.13.1. Press RESET at the end of the cycle to reset the timer to zero and to reset all internal variables.

Note 1: The currently programmed battery test profile remains in memory.

Note 2: Reset will not take effect if in Run. The Charger-Analyzer must be in Hold or Cycle-End for Reset to take effect.

- 3.13.2. Programmed parameters are retained after resetting. The instrument can be re-started with the last programmed parameters.

4. SPECIFICATIONS

4.1 CHARGE

4.1.1. **Maximum Current: 50A**

4.1.2. **Minimum Current: 0.2A**

4.1.3. **Resolution: 0.1A**

4.1.4. **Accuracy: 1% \pm 0.1A**

4.1.5. **Maximum Voltage**

4.1.5.1. 42.5V, one battery

4.1.5.2. 85.0V, two batteries

4.2 DISCHARGE

4.2.1. **Maximum Current: 60A**

4.2.2. **Minimum Current: 0.2A**

4.2.3. **Resolution: 0.1A**

4.2.4. **Accuracy: 1% \pm 0.1A**

4.2.5. **Minimum Voltage**

4.2.5.1. 3V

4.2.6. **Maximum Voltage**

4.2.6.1. 32V for full current and up to 64V at reduced currents (the actual maximum current permitted by the control circuit is limited by the maximum permissible power dissipation).

4.3 TEST MODES

- 4.3.1. Single Rate Constant Current Charge with optional Overvoltage**
- 4.3.2. Single Rate Constant Current Charge with stop at Peak Voltage**
- 4.3.3. Current Limited (constant current) Constant Voltage Charge**
- 4.3.4. Dual Rate Constant Current, Charge with optional Overvoltage**
- 4.3.5. Dual Rate Constant Current, with transfer at Peak Voltage and optional Overvoltage**
- 4.3.6. Constant Current Discharge (Full Discharge)**
- 4.3.7. Constant Current Discharge with voltage cut-off (Capacity Test)**
- 4.3.8. Constant Resistance Discharge with voltage cut-off (Capacity Test)**

4.4 PROTECTION

- 4.4.1. Open Circuit**
 - 4.4.1.1. Absolute Overvoltage sensing
- 4.4.2. Short Circuit**
 - 4.4.2.1. Current limited by programming
- 4.4.3. Reverse Polarity**
 - 4.4.3.1. 0.25V minimum voltage
- 4.4.4. Main Power fuses**
 - 4.4.4.1. Line input (mains) breaker
 - 4.4.4.2. Power Supply
- 4.4.5. Output Limiters**
 - 4.4.5.1. Charge Limiter: 60A, ANL-60 (slow)
 - 4.4.5.2. Discharge Limiter: 80A, ANN-80 (fast)
 - 4.4.5.3. Note: operation with current limiters of rating and types different from indicated may result in damage to charge and/or discharge circuits (voiding the warranty).
- 4.4.6. Overheating**
 - 4.4.6.1. Temperature sensing of the charge and discharge banks

4.5 ENVIRONMENTAL

4.5.1. Ambient Temperature:

4.5.1.1. 5°C to 35°C (41°F to 95°F)

4.5.1.2. Note: For best performance at high temperatures, limit the total dissipation at discharge to 1KW (discharge current x battery voltage) and use a small fan to remove any accumulation of hot air.

4.5.2. Relative Humidity:

4.5.2.1. 95%, non condensing

4.5.2.2. Note: High ambient humidity can lead to corrosion of contacts and other parts.

4.5.3. Altitude:

4.5.3.1. N/A

5. CONTROLS AND DISPLAYS

5.1 FRONT PANEL – see [Figure 13]

5.1.1. METERS

5.1.1.1. Ammeter

5.1.1.2. Voltmeter

5.1.2. LCD DISPLAY

5.1.2.1. Status and programming information

5.1.3. KEYPAD

4 x 6 membrane keypad to enter parameters and controls

5.1.3.1. Numeric keys
0 through 9

5.1.3.2. VIEW

Pressing the View Key plus entering a number (0 to 9) displays a variety of static and dynamic information about the charger-analyzer and its operation. See details at [7.1]

5.1.3.3. FUNC(TION)

Pressing the Function Key plus entering a number, selects a variety of functions to customize the operation of the instrument. See details at [7.2]

5.1.3.4. MODE

Pressing the Mode Key plus entering a number, selects a specific operating mode. See details at [6]

5.1.3.5. BATT(ERY)

Pressing the Battery Key plus entering a number, views, stores and selects battery testing profiles. See details at [7.3]

5.1.3.6. OPT(ION)

Pressing the Option Key plus entering a number, selects a variety of options to customize the operation of the instrument. See details at [7.4]

5.1.3.7. CLEAR

Pressing the Clear Key clears the display and any incomplete entry.

5.1.3.8. TIME

Pressing the Time Key plus entering a number programs time intervals.

- 5.1.3.9. **CURR(ENT)**
Pressing the Current Key plus entering a number programs charge/discharge currents.
- 5.1.3.10. **PAR(AMETER)**
Pressing the Parameter Key plus entering a number programs additional parameters (as applicable to the Mode selected).
- 5.1.3.11. **START (RUN)**
Pressing the Run Key starts/re-starts the operation of the Charger-Analyzer.
- 5.1.3.12. **STOP (HOLD)**
Pressing the Stop Key halts the operation of the charger-analyzer.
- 5.1.3.13. **RESET**
Pressing the Reset Key resets the timer and other internal variables. Note that programmed parameters remain in memory.
- 5.1.3.14. **ENTER**
Pressing the Enter Key registers the parameters programmed.

5.1.4. TIMER

- Elapsed time display
- Hours and Minutes plus colon (or Minutes and Seconds at the faster timer speed).

5.1.5. STATUS

- Displays the status of operation. See TBD for details
- Displays the status of the communication with the BTAS-16 data network

5.1.6. POWER SWITCH

- Main Power Switch (Front Panel Circuit Breaker)

5.1.7. BATTERY CABLE

Connector for the Battery Cable

5.2 REAR PANEL see [Figure 14]

5.2.1. AMBIENT TEMP SENSOR

Connection for an external Ambient Temperature Sensor

5.2.2. TEMP-PLATE

Connection for the external Temp-Plate or Cable to sense battery temperature, (DB9 connector, female)

5.2.3. RESET

Pushbutton to reset the microprocessor

5.2.4. COMPUTER INTERFACE (BTAS-16)

Connection to the BTAS-16 system (6 pin RJ11 connector)

5.2.5. SHUNT (C-Scan, BTAS16)

Provides charge/discharge current information to the C-Scan (DB9 connector, female)



Figure 13 – Front view



Figure 14 - Rear view

6. MODES OF OPERATION

6.1 Parameters Retention

Programmed parameters are lost when power is turned off (store as a Battery Test Profile to retain the values – see [7.3] and [8.3]) and are cleared when programming a new Test Mode (even if it is the same).

6.2 Mode 10

6.2.1. Single Rate Charge

6.2.2. Constant Current

6.2.3. Stop at the end of the programmed time or at detection of programmed OVERVOLTAGE (optional)

6.3 Mode 11

6.3.1. Single Rate Charge

6.3.2. Constant Current

6.3.3. Stop at the selected Peak Voltage

The VOLT END Status indicator will indicate if it reached the programmed PEAK VOLTAGE before reaching the programmed time.

6.3.4. Stop at the end of the selected time

If the programmed PEAK VOLTAGE is not reached

6.4 Mode 12

6.4.1. Single Rate Charge

6.4.2. Constant Current initially then transition to Constant Voltage

6.4.2.1. The transition is dependent on the magnitude of the programmed voltage (from approximately 0.25V to 0.5V)

6.4.3. Stop at the end of the programmed time

6.5 Mode 20

6.5.1. Dual Rate Charge

Automatic transition from CURRENT 1 to CURRENT 2 at the programmed time interval (TIME 1)

6.5.2. Constant Current

6.5.3. Stop at the end of the selected time (TIME 2) or at detection of a programmed OVERVOLTAGE (optional)

6.6 Mode 21**6.6.1. Dual Rate Charge****6.6.2. Constant Current****6.6.3. Transfer on Peak from Main to Topping**

Automatic transition from CURRENT 1 to CURRENT 2 at the detection of the programmed PEAK VOLTAGE

Note: If the peak voltage is not reached, the transition is based on the programmed TIME 1

6.6.4. Stop at the end of the selected time (TIME 2) or at the detection of a programmed OVERVOLTAGE (optional).**6.7 Mode 30****6.7.1. Full Discharge****6.7.2. Constant Current**

Note: The Discharge current will not track (will be lower) at battery voltages below 3V (undercurrent fault is suppressed).

6.7.3. Stop at the end of the programmed time**6.8 Mode 31****6.8.1. Capacity Test****6.8.2. Constant Current****6.8.3. Stop at the selected Capacity Test Voltage or at the end of the programmed time**

The Status indicator (CAP FAIL) will indicate if it reached the programmed Capacity Test Voltage before the programmed time.

6.9 Mode 32**6.9.1. Capacity Test****6.9.2. Constant Resistance****6.9.3. Stop at the selected Capacity Test Voltage or at the end of the programmed time**

The Status indicator (CAP FAIL) will indicate if it reached the programmed Capacity Test Voltage before the programmed time.

7. KEYPAD FUNCTIONS

7.1 VIEW:

7.1.1. V0 – Basic System Information

- Board ID > Product
- Program Version and Date
- Timer Speed

7.1.2. V1 – On-Line Status

7.1.3. V2 – N/A

7.1.4. V3 – N/A

7.1.5. V4 – Heat Sink Temperature (real time)

7.1.6. V5 – Temp-Plate Temperature (real time)

7.1.7. V6 – Ambient Temperature (real time)

7.1.8. V7 – N/A

7.1.9. V8 – Battery Voltage (real time) and Battery Current (real time)

7.1.10. V9 – Fault Processing Option

7.1.11. V10-13 – N/A

7.1.12. V14 – Option

7.1.13. V15-20 – N/A

7.1.14. V21 – Charge Voltage (AC)

7.1.15. V22 – Constant Resistance (Mode 32 Parameter)

7.1.16. V23-24 – N/A

7.1.17. V25 – Power Voltages

7.1.18. V26 - Back-up Battery (real time)

Note: If not running, the voltage will be displayed for about two seconds. If running, the display will be continuous.

7.1.19. V27- Internal Battery Voltage Readings (for test purposes only)

- Available only in RESET

7.1.20. V28 &UP– N/A

7.2 FUNCTION:

7.2.1. F0 – Timer Speed

7.2.1.1. 1 = Normal (HH:MM)

7.2.1.2. 2 = Fast (MM:SS)

7.2.2. F1 – On-Line Status ON (1) and OFF (2) with the BTAS-16

7.2.3. F2 – Fault Processing

7.2.3.1. 1 – Full processing (stop and display error message)

7.2.3.2. 2 – Display error message only (for test purposes only!)

7.2.3.3. 3 – Faults ignored (for test purposes only!)

7.2.4. F3 – Voltmeter Auto Ranging

- On
- Off

7.2.5. F4 – Voltmeter Range (fixed – for Autoranging: Off)

- Low: 20V scale
- High: 200V scale

7.2.6. F5 – N/A

7.2.7. F6 – N/A

7.2.8. F7 – Reset the Communications Processor

7.2.9. F8 – N/A

7.2.10. F9 – N/A

7.3 BATTERY:

7.3.1. View (1)

Views the stored battery test profile at the selected location (Battery #)

7.3.2. Load (2)

Loads a previously stored battery Test Profile (in the selected location) as the current Test Profile

7.3.3. Store (3)

Stores the currently programmed Battery Test Profile in the selected location (non volatile memory)

7.4 OPTION:

7.4.1. 0 – Terminal ID, as 0 to 15, for the BTAS-16

7.4.2. 1 – N/A

7.4.3. 2 – N/A

7.4.4. 3 – Number of batteries

- 0 = Transformers off
- 1 = One Battery (up to 22 cells, 26.4V nominal)
- 2 = Two Batteries (greater than 22 cells, 26.4V nominal)

7.4.5. 4+ - N/A

7.5 PARAMETER:

- Constant Resistance for Mode 32
- Other – (Future functionalities)

8. OPERATING INSTRUCTIONS

8.1 GENERAL

8.1.1. Enter the parameters and commands consistent with the battery being tested.

Check the Battery Manual, CMM or other available instructions for the battery test parameters.

8.2 PROGRAMMING A BATTERY TEST PROFILE

Note that in all cases the decimal point is fixed in the display for the programming of Voltage(s), Current(s) and other Parameter(s). Enter digits as needed to reach the required value. This is equally applicable for the programming of Time(s)

8.2.1. Charge

8.2.1.1. For the Number of Batteries (1 or 2) using Option 3:

- Enter 1 for one battery (or combination of batteries up to a total of 22 cells)
- Enter 2 for one battery (or combination of batteries totaling over 22 cells)

8.2.1.2. MODE 10 - Single Rate Constant Current, with optional Overvoltage

- Select Mode 10
- Enter the elapsed time
- Enter the current
- Enter the Overvoltage value (optional: if zero, it is ignored)

8.2.1.3. MODE 11 - Single Rate Constant Current with peak stop

- Select Mode 11
- Enter the Elapsed Time
- Enter the Current
- Enter the Peak Voltage

8.2.1.4. MODE 12 - Single Rate Constant Voltage

- Select Mode 12
- Enter the Elapsed Time
- Enter the Maximum Current
- Enter the Float Voltage

- 8.2.1.5. MODE 20 - Dual Rate Current, with optional Overvoltage
- Select Mode 20
 - Enter the Main Time (Time 1)
 - Enter the Topping Time (Time 2)
 - Enter the Main Current (Current 1)
 - Enter the Topping Current (Current 2)
 - Enter the Overvoltage value (optional – if zero, it is ignored)
- 8.2.1.6. MODE 21 - Dual Rate Current with Peak Transfer, with optional Overvoltage
- Select Mode 21
 - Enter the Main Time (Time 1)
 - Enter the Topping Time (Time 2)
 - Enter the Main Current (Current 1)
 - Enter the Topping Current (Current 2)
 - Enter the Peak Voltage
 - Enter the Overvoltage value (optional: if zero, it is ignored)

8.2.2. Discharge

- 8.2.2.1. MODE 30 - Full Discharge
- Select Mode 30
 - Enter the Discharge Current
 - Enter the Elapsed Time
- 8.2.2.2. MODE 31 - Capacity Test, Constant Current Discharge
- Select Mode 31
 - Enter the Elapsed Time
 - Enter the Discharge Current
 - Enter the Discharge Cut-off Voltage
- 8.2.2.3. MODE 32 - Capacity Test, Constant Resistance Load
- Select Mode 32
 - Enter the Elapsed Time
 - Enter the Resistance Value (note that discharge current is not programmed)
 - Enter the discharge Cut-off Voltage

8.3 VIEWING, STORING and RETRIEVING the BATTERY TEST PROFILE

8.3.1. View a stored profile

8.3.1.1. Press Battery

8.3.1.2. Select 1 (view)

8.3.1.3. Enter the Battery Profile Number (00 to 10)

8.3.1.4. Note: attempting to view a Battery number that has not been programmed will return N/A

8.3.2. Load a previously stored profile

8.3.2.1. Press Battery

8.3.2.2. Select 2 (load)

8.3.2.3. Enter the profile number (00 to 10)

8.3.2.4. Verify by viewing the programmed values (View Mode)

8.3.2.5. Note: attempting to load a Battery number that has not been programmed will return N/A

8.3.3. Store a new profile

8.3.3.1. Program the Profile (Mode, Time, Current, etc)

8.3.3.2. Press Battery

8.3.3.3. Select 3 (store)

8.3.3.4. Enter the Battery Profile Number (00 to 10)

8.3.3.5. Verify by viewing the programmed values

- Press Battery, Select 0 (view) the Battery Profile Number
- Re-program as required

8.4 STARTING AND STOPPING OPERATION

8.4.1. RUN

- 8.4.1.1. Press START
- 8.4.1.2. The Status Display will acknowledge the start of the cycle
- 8.4.1.3. The Timer will start. The LCD Timer always displays HH:MM:SS. The LED Timer will display HH:MM, the default speed or MM:SS optional fast mode (via Option 0)
- 8.4.1.4. The current will rise to its programmed value over several seconds (soft start and ramp).

8.4.2. STOP

- 8.4.2.1. Press STOP to halt (hold) the operation of the Charger-Analyzer
- 8.4.2.2. Press START to continue or resume a previously halted cycle.

8.4.3. RESET

- 8.4.3.1. Press RESET to reset the timer to zero and to reset all internal variables.
Note 1: The currently programmed battery test profile remains in memory.
Note 2: Reset will not take effect if in Run. The Charger-Analyzer must be in Hold or Cycle-End for Reset to take effect.

9. OPERATING NOTES AND PRECAUTIONS

CAUTION: Disconnect power and batteries before performing any internal maintenance. Failure to observe this caution may result in serious damage to the unit and injury to the operator.

- 9.1 The negative side of the battery cable is connected to chassis ground. Avoid connecting to other equipment where there may be grounding connection incompatibilities. There could be damage due to high current or current path errors.**
- 9.2 Observe Polarity when connecting the charger to a battery or cells.**
- 9.3 Do not start the instrument until a proper connection to a battery or cells has been established.**
- 9.4 Do not disconnect the battery cable from the battery while on charge/discharge (severe damage due to arcing may occur).**
- 9.5 The process of discharging batteries generates a considerable amount of heat.**
 - It is imperative that when installing this instrument that consideration is given to the removal of hot air that may accumulate.
 - Failure to observe this precaution could result in premature breakdown of transistors in the discharge banks.
- 9.6 Operation in dusty environment will reduce the cooling efficiency of the discharge banks.**
 - Failure to observe this precaution could result in premature breakdown of transistors in the discharge banks.

10. INSTALLATION

10.1 BENCH SPACE

10.1.1. Footprint: 19 inches (38.3 cm) wide x 14 inches (35.6 cm) deep

10.1.2. Height: 14 inches (35.6 cm)

10.1.3. Clearance: 6 inches (15.2 cm) all around

- Note: allow for dissipation of air during discharge (use a small fan to help move out the hot air).

10.1.4. Weight: 68 Kg (150 lbs)

10.2 LINE VOLTAGE (mains)

10.2.1. Select the Line Voltage per the Transformers Wiring Block – See [Figure 15] and [Figure 16]

10.2.1.1. Provide a dedicated line with a rating of 30A or better using a motor load type of circuit breaker (high turn-on inrush).

10.2.1.2. For 115V operation, select the 230V wiring and set the number of batteries as N2 (Note: limited current capability)

10.2.2. Fuses and limiters:

10.2.2.1. Main: 40A Circuit Breaker

10.2.2.2. Charge/Discharge – see [Figure 17]

10.2.2.2.1. Charge: 60A, Slow, ANL-60

10.2.2.2.2. Discharge: 80A, fast, ANN-80

10.2.2.3. Power Supply: 4A, 5mm x 20mm

10.2.2.4. Warning! Replacement of fuses and limiters with other types and ratings may result in severe equipment damage and create a fire hazard and will void any applicable warranties.

10.2.3. Power Input (mains):

10.2.3.1. Wall receptacle: Nema630R

Dedicated line, 30A minimum, with a motor load type circuit breaker

Note: operation with a shared line could result in erratic operation

POWER WIRING DIAGRAM 230V (208V)

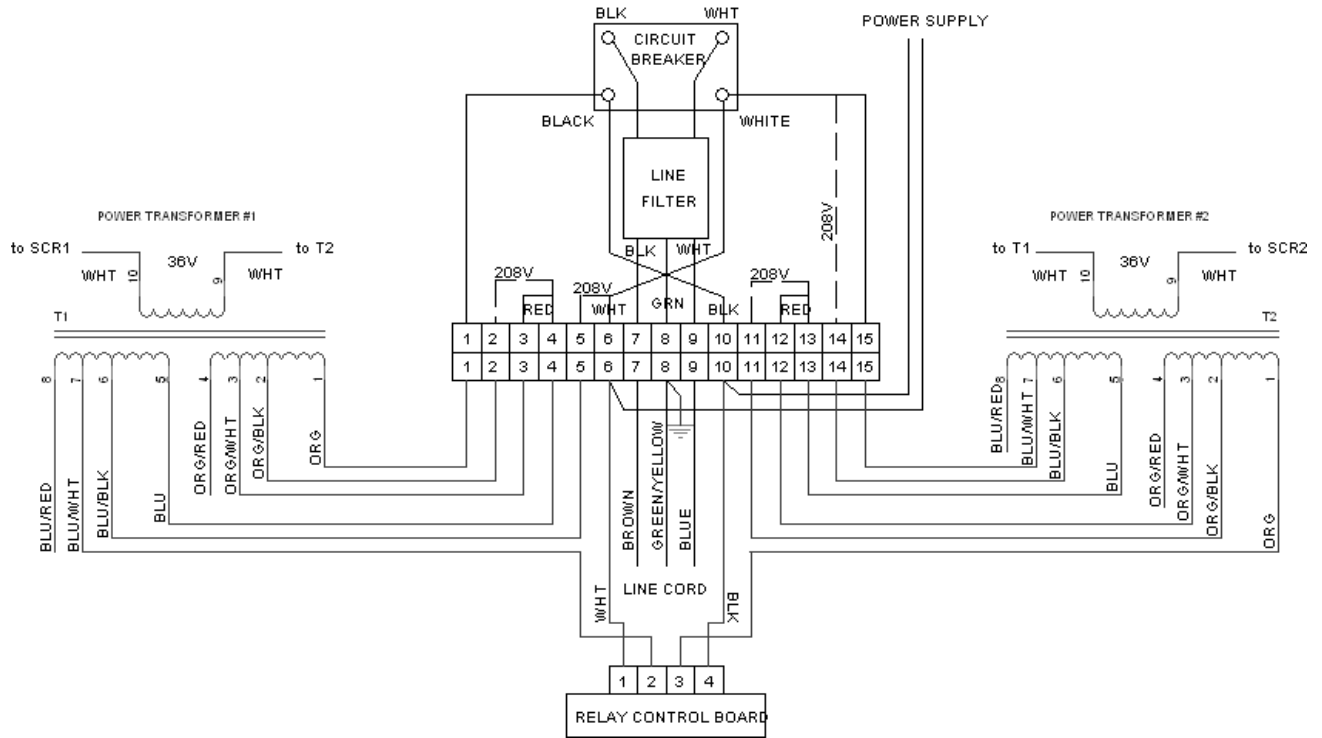

Figure 15 - Line Voltage wiring 208/230

POWER WIRING DIAGRAM 245V (230V)

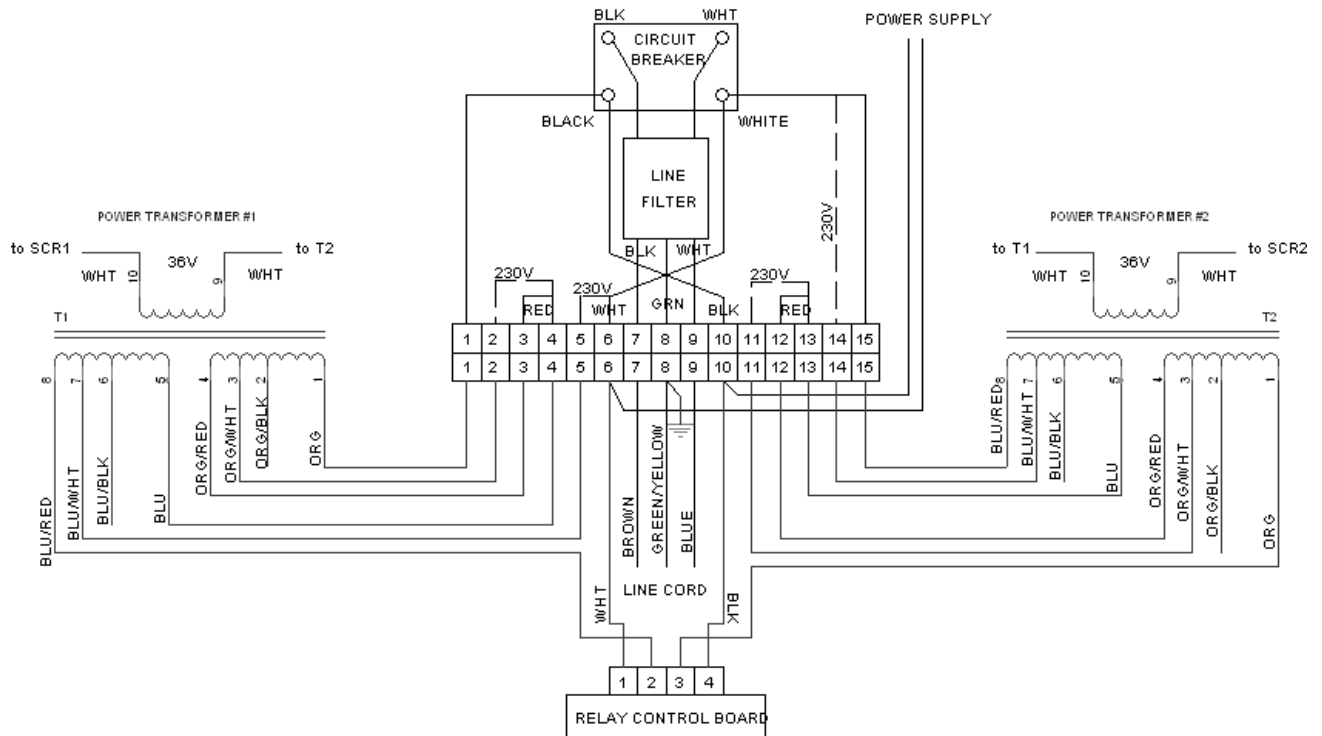

Figure 16 - Line Voltage Wiring 230/245

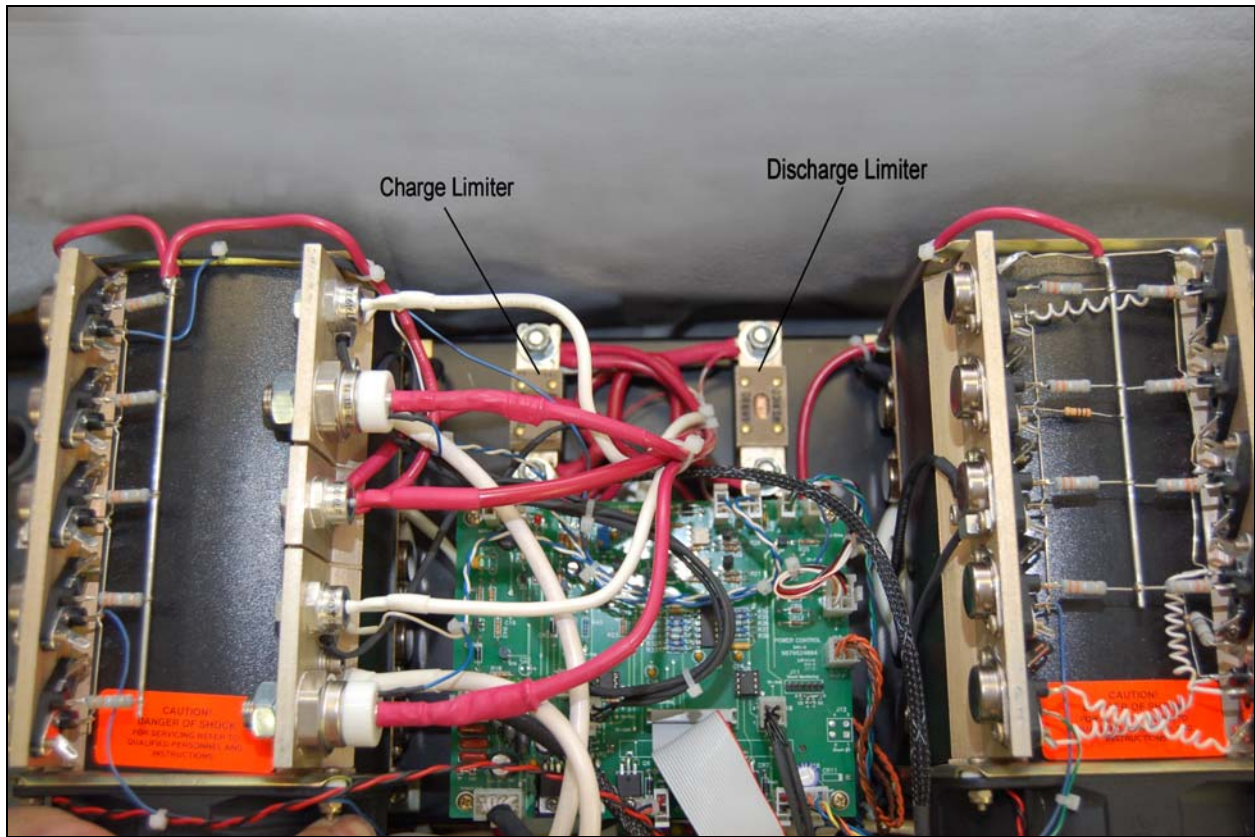

Figure 17 - Current Limiters

10.3 SYSTEM CONNECTIONS

See [Figure 18]

10.3.1. Temp-plate

Connect the cable from the Plate that measures the temperature of the batteries to the top DB9 connector in the Rear Panel.

10.3.2. Shunt output (BTAS16)

Connect a DB9MF cable to the Shunt (output) connector in the Rear Panel to the Shunt (input) connector in the C-Scan.

10.3.3. BTAS16

Connect the 6 conductor cable to the BTAS16 Data Interface.

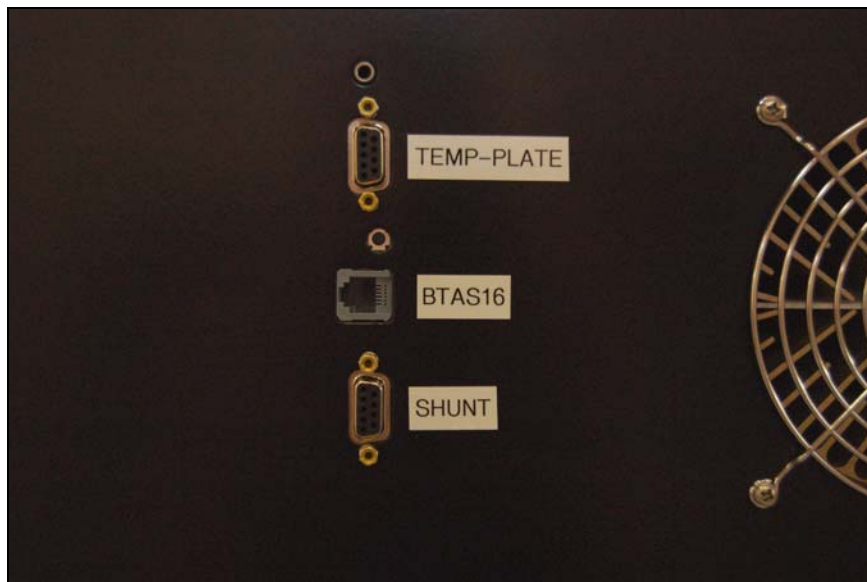

Figure 18 - Rear Panel Connections

11. UPDATES

11.1 Control Program Update – see [Figure 19] and [Figure 20]

The Control Software is located in a plug-in board in the Main Board.

Observe the following to perform an update:

- Disconnect from a battery, disconnect the power cord and remove the cover
- Locate the plug-in board in the top rear center of the Main Board
- Pull out the board (straight – not at an angle)
- Plug-in the board with the updated program (the orientation is with the 10 pin header and reset switch up)
- Verify that all pins are inserted – Warning! The microprocessor will be damaged if the board is not inserted properly.
- Replace the cover and reconnect the power cord
- Turn-on and verify proper operation



Figure 19 - Installed Processor

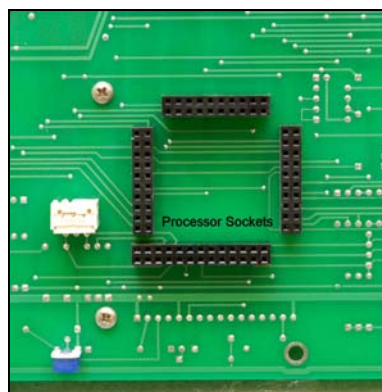

Figure 20 - Processor Sockets

11.2 Communications Program Update – see [Figure 21]

The Communications Software is located in a plug-in integrated circuit located in the Main Board under the LCD display.

Observe the following to perform an update:

- Disconnect from a battery
- Disconnect the power cord
- Remove the cover
- Remove the Main Board from the Front Panel
- Disconnect the Keypad flat cable
- Remove the LCD Display
- Pull out the Integrated Circuit U10 (straight – not at an angle)
- Plug-in the Integrated Circuit with the updated program (the orientation is with pin 1 to the top)
- Verify that all pins are inserted – Warning! The Integrated Circuit will be damaged if it is not inserted properly.
- Re-install the LCD Display
- Reconnect the Keypad Flat Cable
- Mount the Main Board on the Front Panel
- Reconnect the power cord
- Turn-on and verify proper operation



Figure 21 - Communications Processor Socket

12. VERIFICATION OF PERFORMANCE

Note: Perform these tests at least once a year or at any time to determine if the instrument is operating properly

12.1 POWER-UP TESTING

12.1.1. Turn Power ON (rear and front switches)

12.1.2. Verify that the LED displays are lit, including the RESET indicator.

12.1.3. Verify the cycling of information in the LCD display:

12.1.3.1. Initial Screen

```
JFM Engineering, Inc.
  BID=6    TID=0
  24U-1462 18 AUG 2010
  *****
```

Figure 22 – Initial Screen

- BID=1 identifies the ID of the Board
- 24U-1235 identifies the product family and program version (note that the program version will vary as programs are upgraded).
- TID-0 identifies this unit as Terminal #0 (0 to 15) for the BTAS16 system
- 24U-T Identifies the generic product

12.1.3.2. Final Screen

```
T0 M0 00:00:00 N0

Backup Batt=09.45V
Charge Voltage=40V
```

Figure 23 – Final Screen

- T0 is the Terminal ID
- M0 is the Test Mode (0 means no mode selected)
- 00:00:00 is the Timer Display
- Backup Battery is the internal (rechargeable) battery used to maintain the instrument's settings in case of a power failure
- Charge Voltage is the voltage available to the charge circuit.
- N0 is the number of batteries

12.2 KEYPAD and DISPLAY TESTING

12.2.1. View

12.2.1.1. VIEW-0

Basic Information: Program Version, Board ID

```
T0 M0 00:00:00
BID=6 > 24U-S
R-1462 18 AUG 2010
TS=HH:MM
```

Figure 24 – Basic Information Screen

12.2.1.2. VIEW-1

On-Line Status

```
T0 M0 00:00:00

On-Line Status:
0=Off Line
```

Figure 25 – On-Line Status Screen

12.2.1.3. VIEW-2

```
T0 M0 00:00:00 N0

Auto nBA:
1 = Auto
```

Figure 26 – Automatic NBA Status

12.2.1.4. VIEW-3

N/A – Reserved for future use

12.2.1.5. VIEW-4

Heat Sink Temperature (internal)

```

T0 M0 00:00:00 N0
HEATSINK TEMPS
T1=25.0C    T3=25.0C
T2=25.0C    T4=25.0C

```

Figure 26 – Heatsink Temperature Screen

12.2.1.6. VIEW-5

External Battery Temperatures

```

T0 M0 00:00:00 N0
TEMP-PLATE TEMPS
B1=00.0C    B3=00.0C
B2=00.0C    B4=00.0C

```

Figure 27 – Battery Temperature Screen

12.2.1.7. VIEW-6

Ambient Temperature and Auxiliary Input (TBD)

```

T0 M0 00:00:00 N0

AMB=00.0C    AUX=0000

```

Figure 28 – Ambient Temperature Screen

12.2.1.8. VIEW-7

Internal Voltage (test only)

12.2.1.9. VIEW-8

Battery Voltage/Current

Note: current will show when running a test

```

T0 M0 00:00:00
BATT VOLTAGE/CURRENT

BV=00.0V

```

Figure 29 – Battery Voltage/Current Screen

12.2.1.10. VIEW-9

Fault Processing Option

```
T0 M0 00:00:00  
  
FAULT OPTION  
FP = 1
```

Figure 30 – Fault Processing Option Screen

12.2.1.11. VIEW-10 & 11

N/A

12.2.1.12. VIEW-14

Option

```
T0 M0 00:00:00 N0  
  
Enter Option #  
Option #:__
```

Figure 31 – View Option Screen

12.2.1.13. VIEW-21

Charge Voltage

```
T0 M0 00:00:00  
  
Charge Voltage=40
```

Figure 32 – Charge Voltage Screen

12.2.1.1. VIEW-22

Constant Resistance Value (Mode 32 only)

```
T0 M0 00:00:00  
  
RESISTANCE  
N/A
```

Figure 33 – Constant Resistance Screen

12.2.1.2. VIEW-25

Power voltages

T0	M0	00:00:00	N0
-5V=5.00		REF=2.500	
10V=10.0		+5V=5.00	

Figure 34 – View Power Voltages Screen

12.2.1.3. VIEW-26

Backup Battery

T0	M0	00:00:00	N0
BUB=09.5V		+5V=5.00	

Figure 35 – View Backup Battery Screen

12.3 Function

12.3.1. FUNCTION-0

Timer Speed

```
T0 M0 00:00:00 N0
Timer Speed
Option Value: __
```

Figure 36 – Timer Speed Screen

12.3.2. FUNCTION-1

On-Line Status

12.3.3. FUNCTION-2

Fault Processing

12.3.4. FUNCTION-3

Autoranging

12.3.5. FUNCTION-4

Voltmeter Scale

12.3.6. FUNCTION-5

N/A

12.3.7. FUNCTION-6

N/A

12.3.8. FUNCTION-7

Forced Transfer from Main to Topping

12.3.9. FUNCTION-8 & UP

N/A

12.4 Option

12.4.1. OPTION-0

Terminal ID

T0 M0 00:00:00 N0
Terminal ID
Option Value: __

Figure 37 – Terminal ID Screen

12.4.2. OPTION-1

N/A

12.4.3. OPTION-2

- Enter 0 for Manual entry of Number of Batteries
- Enter 1 for Automatic entry of Number of Batteries

12.4.4. OPTION-3

- Enter 1 for one battery (or combination of batteries totaling up to 22 cells)
- Enter 2 for two batteries (or combination of batteries totaling over 22 cells)
- The number of batteries selected is displayed as N0 (none), N1 (one) and N2 (two).

T0 M0 00:00:00 N0
Number of Batteries
Option Value: __

Figure 38 – Number of Batteries Option

12.4.5. OPTION-4 & UP

N/A

12.5 POWER TESTS

12.5.1. Voltage:

12.5.1.1. Voltmeter

12.5.1.1.1. Connect to an external voltage source (CAL-100)

12.5.1.1.2. Adjust the external voltage to about between 19.00V

12.5.1.1.3. Verify that the voltmeter displays 19.00V \pm 0.02V

12.5.1.1.4. Verify Voltmeter readings at 5V, 10V, 20V, 25V, 30V, 40V and 80V (N2)

12.5.2. Internal Reading

12.5.2.1. Select VIEW-1

12.5.2.2. Verify that the internal voltage reading is within \pm 0.2V

12.5.2.3. Clear

12.5.3. Overvoltage

12.5.3.1. Set N1 (via option 3)

12.5.3.2. Increase the voltage towards 45.00V

12.5.3.3. Verify that an Absolute Overvoltage indication takes place at about 45V

12.5.3.4. Repeat for N2 at 90V

12.5.3.5. Reset

12.5.4. Reverse Polarity

12.5.4.1. Decrease the voltage to zero

12.5.4.2. Reverse the polarity

12.5.4.3. Increase the voltage towards -0.25V

12.5.4.4. Verify that a Reverse Polarity indication takes place between 0.10V and 0.20V

12.5.4.5. Reset

12.5.5. Voltage set points

- 12.5.5.1. Adjust the external voltage to about 19.75V
- 12.5.5.2. Program Mode 11 with 1 minute, zero current and 20.00V
- 12.5.5.3. Run
- 12.5.5.4. Verify that the cycle ends at $20.00 \pm 0.02V$
- 12.5.5.5. Reset
- 12.5.5.6. Adjust the external voltage to 20.25V
- 12.5.5.7. Program Mode 31 with 1 minute, zero current and 20.00V
- 12.5.5.8. Run
- 12.5.5.9. Decrease the voltage and observe that Capacity Failure is acknowledged at $20.00V \pm 0.02V$
- 12.5.5.10. Reset

12.5.6. Current

12.5.6.1. Connect to a load (battery)

12.5.6.2. CC Charge – High Current

12.5.6.2.1. Connect to a battery with a reference shunt (ammeter) in the negative side.

12.5.6.2.2. Program Mode 10 with 10 minutes, 25.0A and zero voltage

12.5.6.2.3. Run

12.5.6.2.4. Verify that the Fan turns on automatically.

12.5.6.2.5. Verify that the displayed current is 25.0A, $\pm 0.1A$

12.5.6.2.6. Select VIEW-1

<p>T0 M0 00:00:00 N1 BATT VOLTAGE/CURRENT BV=XX.XV CHG=025.0A</p>

Figure 39 – View Battery Voltage and Current Screen

- Verify that the displayed voltage is within $\pm 0.2V$
- Verify that the current is within $\pm 0.2A$

12.5.6.2.7. Stop and Reset

12.5.6.3. Short Circuit

12.5.6.3.1. Disconnect the battery

12.5.6.3.2. Short the output leads

12.5.6.3.3. Run

12.5.6.3.4. Verify that the current remains at 25.0A

12.5.6.3.5. Stop and Reset

- 12.5.6.4. CC Charge – Low Current
 - 12.5.6.4.1. Re-Connect to the battery
 - 12.5.6.4.2. Program the current as 1.0A
 - 12.5.6.4.3. Run
 - 12.5.6.4.4. Select VIEW-8
 - 12.5.6.4.5. Verify that the internal current reading is within $\pm 0.1A$
 - 12.5.6.4.6. Clear
 - 12.5.6.4.7. Stop and Reset
- 12.5.6.5. Open Circuit
 - 12.5.6.5.1. Disconnect the battery
 - 12.5.6.5.2. Caution! Charge voltage will be present at the battery cable
 - 12.5.6.5.3. Run
 - 12.5.6.5.4. Verify that after two seconds there is an Absolute Overvoltage message
 - 12.5.6.5.5. Reset
- 12.5.6.6. CV Charge
 - 12.5.6.6.1. Connect to a 24V Sealed Lead-Acid battery
 - 12.5.6.6.2. Program Mode 12 with 10 minutes, 10.0A and 26.00V
 - 12.5.6.6.3. Run
 - 12.5.6.6.4. Observe that the current diminishes as the battery charges-up to the programmed voltage
 - 12.5.6.6.5. Stop and Reset

12.5.6.7. Discharge – High Current

- 12.5.6.7.1. Connect to a 24V battery or power supply capable of at least 30A
- 12.5.6.7.2. Program Mode 30 with 10 minutes and 30.0A
- 12.5.6.7.3. Run
- 12.5.6.7.4. Select VIEW-8
- 12.5.6.7.5. Verify that the internal current reading is within $\pm 0.3A$
- 12.5.6.7.6. Clear
- 12.5.6.7.7. Select VIEW-4
- 12.5.6.7.8. Observe the Heat Sink temperature indication.
- 12.5.6.7.9. Verify that the temperatures do not differ by more than $5^{\circ}C$

T0	M0	00:00:00	N0
HEATSINK TEMPS			
T1=33.0C		T3=33.2C	
T2=33.1C		T4=33.0C	

Figure 40 – View Heat Sink Temperatures Screen

- 12.5.6.7.10. Verify that at about $32^{\circ}C$ the Fan turns on slowly and accelerates as the temperature increases.
 - 12.5.6.7.11. Clear
 - 12.5.6.7.12. Stop and Reset
- 12.5.6.8. Discharge – Low Current
- 12.5.6.8.1. Re-Program the current to 1.0A
 - 12.5.6.8.2. Run
 - 12.5.6.8.3. Select VIEW-8
 - 12.5.6.8.4. Verify that the internal current reading is within $\pm 0.2A$.
 - 12.5.6.8.5. Clear
 - 12.5.6.8.6. Stop and Reset

12.5.6.9. CR Discharge

- 12.5.6.9.1. Connect to a 24V source (Power Supply or Battery)
- 12.5.6.9.2. Program Mode 32 with 10 minutes, 24.00 ohms and 20.00V
- 12.5.6.9.3. Run
- 12.5.6.9.4. Observe that the current starts at approximately 1A (Input Voltage divided by 24.00 ohms) and that the current diminishes as the input voltage diminishes.
- 12.5.6.9.5. Stop and Reset
- 12.5.6.9.6. Connect to a 12V source (Power Supply or Battery)
- 12.5.6.9.7. Program Mode 32 with 10 minutes, 12.00 ohms and 10.00V
- 12.5.6.9.8. Run
- 12.5.6.9.9. Observe that the current starts at approximately 1A (Input Voltage divided by 12.00 ohms) and that the current diminishes as the input voltage diminishes.
- 12.5.6.9.10. Stop and Reset

12.6 Other

12.6.1. Power Fail

- 12.6.1.1. Connect to a battery
- 12.6.1.2. Program Mode 10 with 10 minutes, 1.0A and zero voltage
- 12.6.1.3. Run
- 12.6.1.4. Turn the power off
- 12.6.1.5. Observe that POWER FAIL is acknowledged in the LCD screen and that the colon turns on.

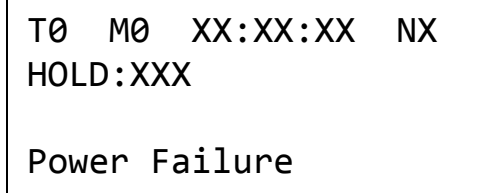

T0 M0 XX:XX:XX NX
HOLD:XXX

Power Failure

Figure 41 – Power Fail Screen

- 12.6.1.6. Turn power back on
- 12.6.1.7. Observe that the LCD screen acknowledges a power fail recovery and that the instrument resumes charging.

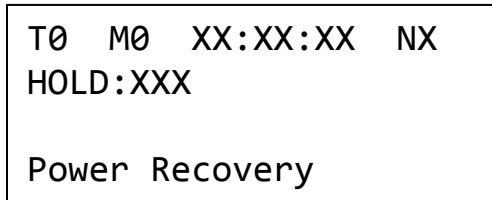

T0 M0 XX:XX:XX NX
HOLD:XXX

Power Recovery

Figure 42 – Power Fail Screen #1

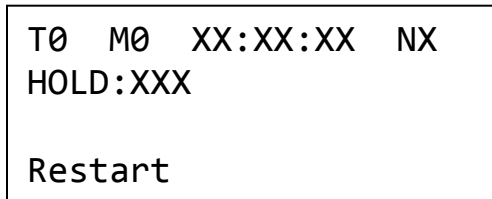

T0 M0 XX:XX:XX NX
HOLD:XXX

Restart

Figure 43 – Power Fail Screen #2

- 12.6.1.8. Stop and Reset

13. CALIBRATION

Note: Perform these adjustments only if the Verification of Performance indicates that the Instrument is not operating as specified.

CAUTION: Disconnect power and batteries before performing any internal maintenance. Failure to observe this caution may result in serious damage to the unit and injury to the operator.

13.1 Reference Illustration

See [Figure 44] for location of adjustments

13.2 Voltmeter

- 13.2.1. Connect the instrument to a voltage source (Battery, Power Supply or Calibrator)
- 13.2.2. Monitor the Voltage Source with a Reference Voltmeter
- 13.2.3. Select/adjust the voltage to under 20V (18V to 19.9V)
- 13.2.4. Adjust R20 for the Voltmeter in the instrument to match the reading of the external Reference Voltmeter (± 2 digits)
- 13.2.5. Select a voltage between 40 and 60V
- 13.2.6. Verify that the voltmeter in the instrument matches the external Reference Voltmeter

13.3 Ammeter

- 13.3.1. Connect the instrument to a battery with a reference ammeter in series with any of the leads.
- 13.3.2. Program Mode 10, 1 minute and 25.0A
 - 13.3.2.1. Start the instrument and wait for the current to stabilize.
 - 13.3.2.2. Observe the reading in the Reference Ammeter.
 - 13.3.2.3. Adjust R8 in the Main Board as needed for the Ammeter to display to equal the reading in the Reference Ammeter.
 - 13.3.2.4. *Note: there is a separate Ammeter calibration for Discharge [13.7.1.3]*
 - 13.3.2.5. Stop

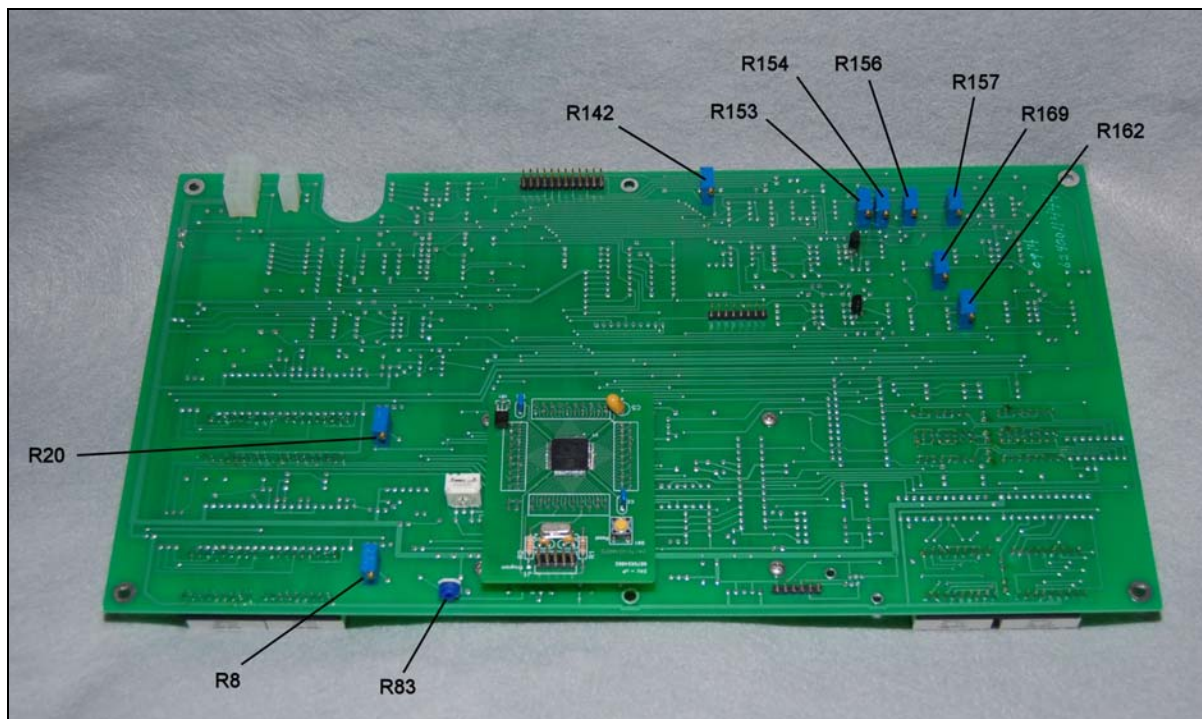

Figure 44 - Main Board with Numbered Adjustments

13.4 Charge Current (high)

13.4.1. Re-start and adjust R153 in the Main Board as needed for the output current in the Ammeter to read 25.0

13.4.2. Stop

13.5 Charge Current (low)

13.5.1. Program 1.0A

13.5.2. Re-start and adjust R162 as needed for the output current in the Ammeter to read 1.0

13.6 Repeat [13.4] and [13.5] as needed

13.6.1. Stop and Reset

13.7 Discharge Current (high)

13.7.1 Program Mode 30, 1 minute and 30.0A

- 13.7.1.1. Start the instrument and wait for the current to stabilize.
- 13.7.1.2. Adjust R154 in the Main Board as needed for the output current in the Reference Ammeter to read 30.0.
- 13.7.1.3. Adjust R142 in the Main Board as needed for the Ammeter display to equal the reading in the Reference Ammeter.
- 13.7.1.4. *Note: The Ammeter Calibration for Charge [Error! Reference source not found.] must be performed before the Ammeter Calibration for Discharge.*
- 13.7.1.5. Stop

13.8 Discharge Current (High)

- 13.8.1. Re-Start and adjust R154 in the Main Board as needed for the output current in the Ammeter to read 30.0A**
- 13.8.2. Stop**

13.9 Discharge Current (low)

- 13.9.1. Program 1.0A**
- 13.9.2. Re-start and adjust R169 as needed for the output current in the Ammeter to read 1.0A**

13.10 Repeat [13.8] and [13.9] as needed

- 13.10.1. Stop and Reset**

13.11 Peak Voltage (also applicable to Capacity)

- 13.11.1. Connect the instrument to an adjustable voltage source (Power Supply or Calibrator) initially adjusted to approximately 30V (under 31V)**
- 13.11.2. Program Mode 11, 1 minute, zero current and 31.0V**
- 13.11.3. Start the instrument and increase the voltage source towards 31.0V**
- 13.11.4. Adjust R156 as needed to make the instrument stop on the programmed peak voltage**
- 13.11.5. Repeat as needed**
- 13.11.6. Stop and Reset**

13.12 Constant Voltage

- 13.12.1. Connect the instrument to a battery (12V or 24V)
- 13.12.2. Program Mode 12, 10 minutes, current as applicable to the A-hr rating of the battery and 13.8V (or 27.6V)
- 13.12.3. Start the Instrument and adjust R157 as needed to achieve the programmed voltage
- 13.12.4. Stop and reset

13.13 Charge Voltage Display

- 13.13.1. With the instrument in RESET, measure and record the AC voltage at the SCRs (CAUTION!) – See [Figure 45]

Note: for N1 it should be about 40V and 80V for N2 (line voltage dependent)

- 13.13.2. Select View 31

Adjust R13 in the Power Control Board to match the reading previously obtained. See [Figure 46]

Note: this is for indication only (accuracy not required).

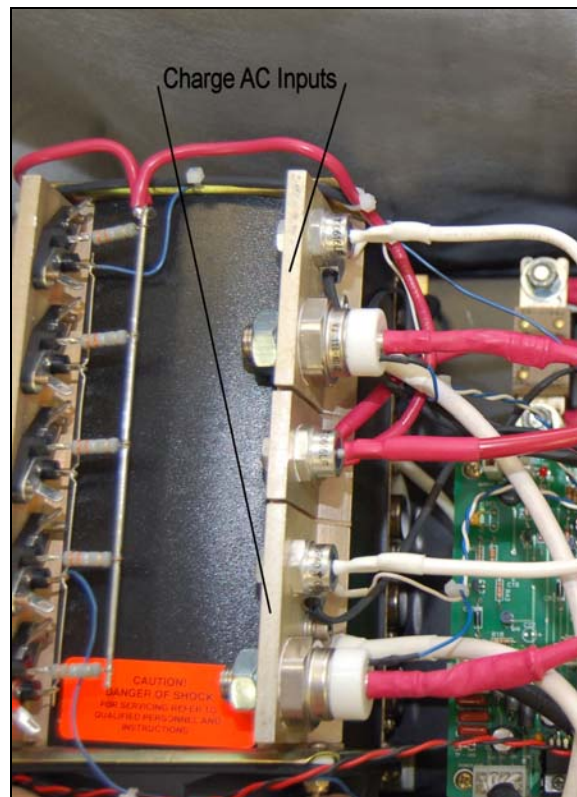

Figure 45 - Charge AC inputs

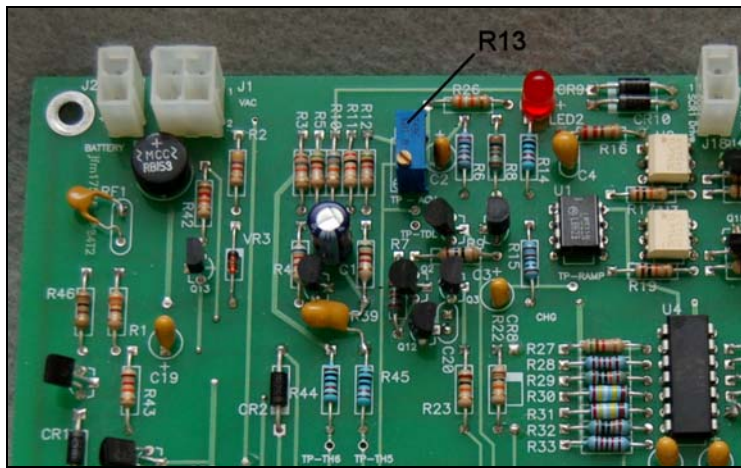

Figure 46 – Power Control Board Charge Voltage Display Adjust

14. TROUBLESHOOTING AND REPAIRS

CAUTION: *Disconnect power and batteries before performing any internal maintenance. Failure to observe this caution may result in serious damage to the unit and injury to the operator.*

The following are hints and directions to help you locate the most probable causes of deviation of performance as established in the procedures of section [12] Verification of Performance.

14.1 ERROR MESSAGES

14.1.1. “Invalid BID”

The Board ID number is not in the expected range

14.1.2. “Power Failure”

The Processor has sensed a loss of power and it is running on its backup battery [see 12.6.1]

14.1.3. “Reverse Polarity”

Connection to the battery with the polarity reversed [see 12.5.4]

14.1.4. “Absolute Overvoltage”

The voltage sensed at the battery input exceeds the limit for the instrument [see 12.5.3 and 12.5.6.5]

14.1.5. “Open Limiter”

The Charge Limiter (fuse) or the Discharge Limiter (fuse) is open

14.1.6. “Heat Sink Overheat”

The temperature at the discharge bank heat dissipator is above 90°C (194°F)

14.1.7. “Battery Overtemp”

The temperature of the battery under test (charge) is above 40°C (104°F) as measured by the Temp-Plate Temperature Sensors

14.1.8. “Capacity Failure”

In Test Mode 31, the Battery Voltage is below the programmed minimum Voltage [see 12.5.5.9]

14.1.9. “Overvoltage”

In any of the Charge Test Modes, the Battery Voltage is above the programmed maximum Voltage [see 12.5.3]

14.1.10. “Low AC”

Insufficient AC (mains) voltage for charging

14.1.11. “Over Dissipation”

The product of the Programmed Discharge Current times the Battery Voltage is above the maximum limit for the instrument

14.1.12. “Mode not Defined”

Attempting to Run or to program parameters without first having programmed the Test Mode [see 3.3]

14.1.13. “Not for this Mode”

Attempting to program a parameter not applicable to the selected Test Mode

14.1.14. “Invalid Terminal ID”

Attempting to apply an invalid Terminal ID for the BTAS16 (0 through 15 only) [see 7.2.1]

14.1.15. “N entry error”

Attempting to enter an invalid number of batteries (0, 1 or 2 only) [see 3.3.1 and 7.4.4]

14.1.16. “No Current Prog”

For Test Mode 32 attempting to enter a value for current

14.1.17. “Under Current”

The Processor has detected that the current being delivered (or taken) is below the programmed value

14.1.18. “Over Current”

The Processor has detected that the current being delivered (or taken) is above the programmed value

14.1.19. “Charge Overvoltage”

In any of the Charge Test Modes, the Battery Voltage is above the programmed maximum Voltage

14.1.20. “Excessive Current”

In Test Mode 32 the current calculated per the programmed Resistance and the Battery Voltage at the terminals is above the limit for this instrument

14.1.21. “Low Battery Voltage”

In any of the Discharge Test Modes the Battery Voltage at the terminals is below 3V

14.1.22. “PV < BV”

For Test Modes 11, 12 and 21, the programmed Voltage is below the Battery Voltage present at the terminals

14.1.23. “PV > BV”

For Test Modes 31 and 32, the programmed Voltage is above the Battery Voltage present at the terminals

14.1.24. “Time Entry Error”

Attempting to program an invalid time (e.g., 01:60) [see 3.4.1]

14.2 TROUBLESHOOTING**14.2.1. Misc:**

- 14.2.1.1. Starts but stops in one second.
Time not programmed (zero).
- 14.2.1.2. Starts but there is no current.
- Current not programmed (zero)
 - Battery(ies) not connected
- 14.2.1.3. The voltmeter registers a voltage (approximately 36 volts) with the unit in reset and the battery is not connected.
One or both SCR'S shorted.
Do not connect a battery under this condition!
- 14.2.1.4. Power is turned on (by the breaker) but nothing turns-on in the Front Panel.
Power Supply Cable(s) not connected or open. Open fuse in the Power Supply or defective Power Supply.
- 14.2.1.5. Current tracking is off by a small constant amount.
Low current calibrate out of adjustment. See [13.5] and/or [13.9]
- 14.2.1.6. Current tracking is off by a small amount which increases as the programmed value is increased.
High current calibrate out of adjustment. See [13.4] and/or [13.7]
- 14.2.1.7. Starts but exhibits a current fault after some time (from a few seconds to a few minutes).
Current tracking is off, see above.
- 14.2.1.8. Power is on but fans are off.
- For charge, fans will not turn on until a charge is started
 - For discharge, fans turn on when the temperature of the discharge banks reaches approximately 32°C.

14.2.2. Charge specific:

- 14.2.2.1. Absolute Overvoltage error message
Battery(ies) not connected or open link.
- 14.2.2.2. Charges one battery properly but cannot charge two batteries at high rates (current fault).
- Low line voltage.
 - Improper transformer primaries tap settings.
- 14.2.2.3. Unit goes into voltage fault immediately or shortly after starting up in any of the charge modes.
Battery not properly connected. Loose/Open link. Loose/Open Battery Cable.
- 14.2.2.4. Charges low current (below 10 amps) properly but hums noticeably at higher currents.
One of the SCR's is inoperative, or one of the rectifiers is open.
- 14.2.2.5. Open Charge Limiter, small crack.
Inconsequential opening. Replace and resume operation.
- 14.2.2.6. Open Charge Limiter, blown element (vaporized).
Shorted SCR(s).

14.2.3. Discharge specific:

- 14.2.3.1. Low Battery Voltage error message
Battery(ies) not connected, open link or under 3V
- 14.2.3.2. Starts in the Capacity Test Mode but goes into capacity failure immediately.
Battery not properly connected. Loose/Open link. Loose/Open Battery Cable.
- 14.2.3.3. Open Discharge Limiter, small crack.
Inconsequential opening. Replace and resume operation.
- 14.2.3.4. Open Discharge Limiter, blown element (vaporized).
Shorted discharge transistors. See [14.3]
- 14.2.3.5. The discharge current limiter opens the moment a battery is connected to the charger.
Shorted discharge transistors(s). See [14.3]
- 14.2.3.6. Burned resistor(s) in the discharge heatsink(s).
One or more transistors shorted and the discharge current limiter did not open (wrong limiter value or type). See [14.3]

14.3 FINDING A SHORTED DISCHARGE TRANSISTOR

Since all discharge transistors are wired in parallel, a single shorted transistor will short the entire bank.

The procedure that follows will allow the finding of the shorted transistor without requiring removal and testing of each device individually.

14.3.1. EQUIPMENT REQUIRED

- Digital Voltmeter.
- Battery, 24V.
- Lamp, 24V or two 12V in series (lamp(s) must draw at least 0.5 A).

14.3.2. PROCEDURE

- 14.3.2.1. Turn the unit OFF, disconnect it from the wall outlet.
- 14.3.2.2. Connect the lamp in place of the discharge current limiter
- 14.3.2.3. Connect the charger to the battery.
- 14.3.2.4. If the lamp illuminates, it indicates that there is a short in the discharge circuit, generated by one or more shorted transistors.
- 14.3.2.5. Measure the voltage across the individual 0.33 OHM resistors (ORG-ORG-GOLD-GOLD)
 - A non zero reading, approximately 0.15V for a lamp drawing 0.5A, indicates current flow due to a transistor with a collector to emitter short.
 - NOTE: A non zero reading on all emitter resistors (0.02V approx for a lamp drawing 0.5A) indicates a different failure mode (collector to base short; refer to step [14.3.2.7.]
- 14.3.2.6. Remove any shorted transistors and repeat steps 4 and 5 until a no short reading is obtained. Replace defective devices only with transistor type MJ15023 (P/N 4822J15023).
- 14.3.2.7. If all transistors appear to be shorted (ALL emitter resistors reading a voltage), then, one or more have failed with a collector to base short, causing the remainder of the transistors to turn on. It will then be necessary to check each transistor individually.
 - This can be greatly facilitated by searching for a zero reading. This will indicate the shorted device.

14.3.2.8. When replacing transistors, make sure that the base and emitter pins engage properly in the socket contacts. Add heat sink compound and torque the screws properly to insure a good thermal transfer.

- NOTE: If replacing any of the control transistors (Q1 and Q2), note that they are mounted with a mica insulator.

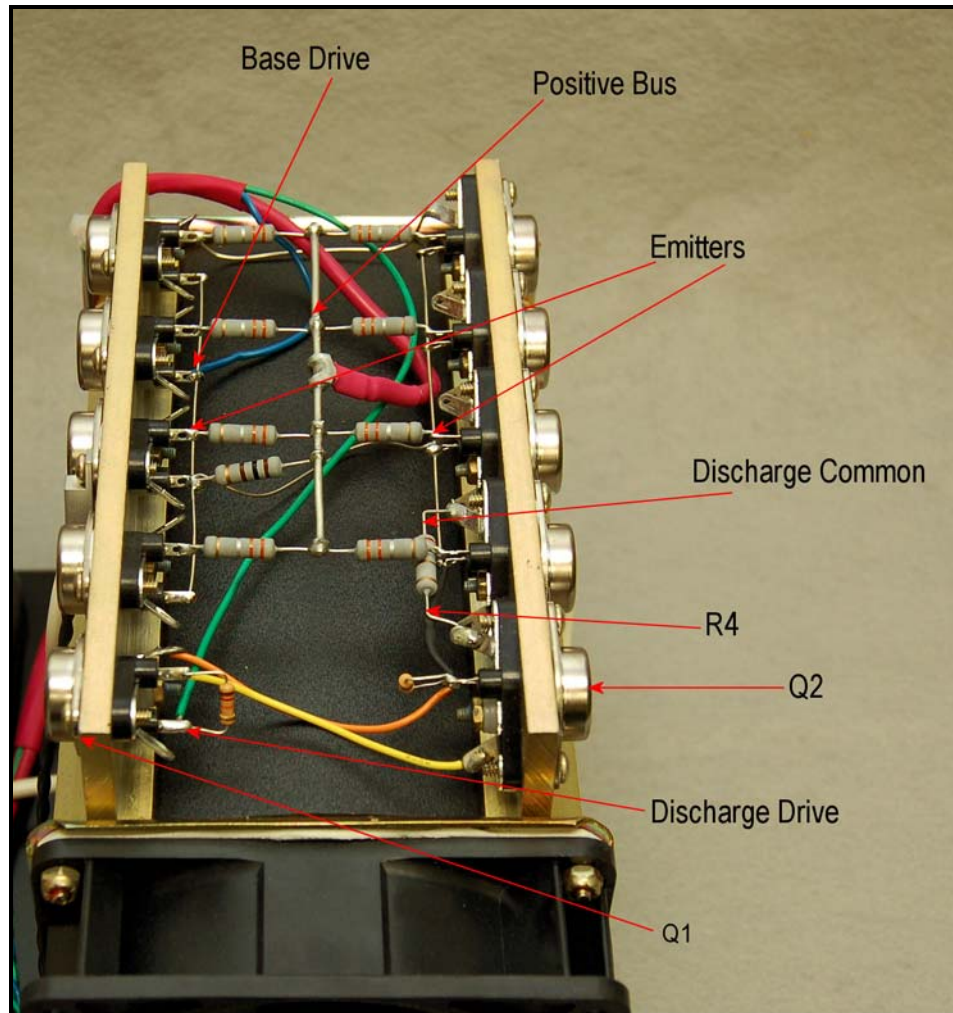

Figure 47 - Open resistor measurement

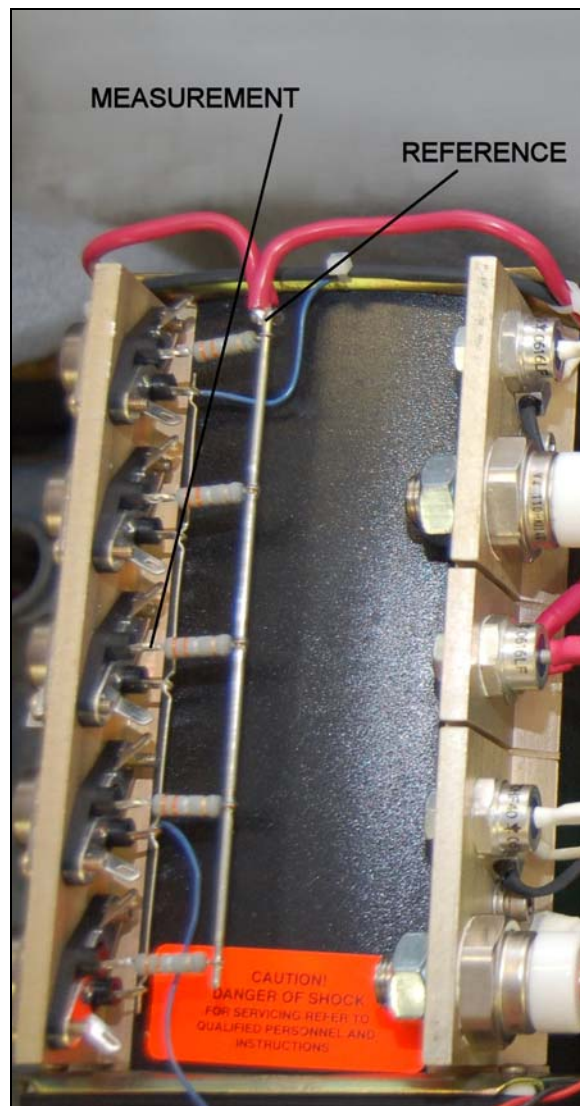

Figure 48 - Open Resistor measurement

15. POWER BLOCK DIAGRAM

16. REPLACEABLE MODULES AND PARTS

- 16.1 Microprocessor Circuit Board – P/N 9879624002**
- 16.2 Main Circuit Board – P/N 9879624011**
- 16.3 Power Control Circuit Board – P/N 9879624004**
- 16.4 Relay Control Board – P/N 9879624006**
- 16.5 I/O Circuit Board and Harness – P/N 9862603004**
- 16.6 Power Supply Cable – P/N 9861603001**
- 16.7 Power Feed Cable – P/N 9861603002**
- 16.8 Power Supply – P/N 4022PT65A0**
- 16.9 Battery Cable, one battery connector – P/N 9895603801**
- 16.10 Battery Cable, two battery connector – P/N 9895603802**
- 16.11 Relay Control Cable – P/N 9861603004**
- 16.12 Discharge Transistor MJ15023 – P/N 4822J15023**
- 16.13 Discharge Driver MJ15001 – P/N 4822J15001**
- 16.14 Discharge Driver MJ15002 – P/N 4822J15002**
- 16.15 SCR Assembly – P/N 9821603401**
- 16.16 Charge Diode Assembly – P/N 9831603402**
- 16.17 Discharge Diode Assembly – P/N 9821603403**
- 16.18 Battery Cable – P/N 9895603801**

17. BATTERY TESTING NOTES

Note: Battery testing is a hazardous operation. Handle batteries with extreme care as they are capable of very high discharge currents if short circuited.

Check the Battery Manual, CMM or Aircraft Manufacturer Instructions for information on charging, discharging and testing.

For Nickel-Cadmium batteries, the most effective charge method is constant current vs. time. In the absence of any particular instructions from the manufacturer, charging at $c/10$ for 12 to 16 hours will insure a complete charge.

Specifically for main batteries, the typical charge profile is $C/5$ for 2 hours followed by $C/10$ for 4 hours.

The Nickel-Cadmium batteries can also be charged in the float mode, with a voltage of 1.4 V/cell (a 20 cell battery would be set to 28.0V).

The Charge & Float and the Charge & Peak Stop modes are particularly useful with lead acid batteries, where the battery voltage is a better indicator of the state of charge, as compared with Nickel-Cadmium batteries where terminal voltage gives much less information on the state of charge.

Lead-Acid batteries are normally float charged (constant voltage) typically at 2.33V/cell. A 6 cell pack (12V) will then be float charged with the voltage programmed at 13.8V. In this mode, the charge current is set to the highest level that the cells will safely take (typically up to 1C depending on the battery type and specific instructions from the manufacturers). This will be the charge current until the float voltage is reached, at which time the current will diminish to the level needed to maintain the programmed float voltage.

Lead-Acid batteries can also be charged in a manner in which it is possible to know much better the end of charge. When a Lead-Acid cell is charged with constant current at $C/15$ to $C/10$, the end voltage will rise rapidly at about 90 to 95% of charge, which occurs at about 2.4 to 2.45V/cell. A 5A-hr, 6 cell battery can be charged at 335mA to 500mA, with the peak voltage programmed at 14.7V. The Instrument will stop the charge operation when the rapid rise of end-of-charge voltage is detected.

18. DISCLAIMER

18.1 This Charger-Analyzer is a precision instrument intended to be operated by personnel qualified in the servicing of aircraft, industrial or medical batteries.

18.2 JFM Engineering's responsibility is limited to the repair/replacement of any malfunctioning part of the system (not responsible for any losses incurred from the usage of the system).

18.3 User's Responsibility

- It is the user's responsibility to verify suitability in the intended application.
- It is the user's responsibility to verify the performance of the instruments and to operate and maintain it in accordance with the above given instructions.
- It is the user's responsibility to test batteries in accordance to the instructions and recommendations of the manufacturers of the batteries.
- It is the user's responsibility to operate the Instrument within standard safety procedures applicable to the operation of a Battery Test Facility.
- It is the user's responsibility to install power receptacles and wiring in accordance with local wiring codes.
- It is the user's responsibility to observe all necessary precautions and to be equipped with personal protective equipment when working with batteries to avoid injury due to electrolyte splashing, short circuits with tools and to avoid injury due to the size and weight of the batteries.
- It is the user's responsibility to verify the integrity of the performance of this instrument in accordance with the instructions of Section 12.
- It is the user's responsibility to operate this instrument within the limits and guidelines as described in the Precautions and Installation sections (9 and 10).
- It is the user's responsibility to properly package the instrument for shipping whenever factory service is required.

19. REVISION INDEX

Table 1 - Index of Revisions

REVISION	DATE	NOTES
E10	11 September 2007	Preliminary release
E11	8 October 2007	Operational and Verification Updates
E12	15 October 2007	Screens and instruction updates
E13	22 October 2007	Changes in viewing screens
RM14	21 August 2008	Correction to screen 25
RM15	9 February 2009	Misc Updates
V17	12 March 2009	Program Version 1437 - Number of Batteries (option3) and Misc Text Updates
V18.01	7 April 2009	Error messages and calibration illustrations added
V18.02	20 April 2009	Illustrations and fuse information added
V18.03	27 April 2009	Additional troubleshooting information
V19.0	13 August 2009	Program version 1450 - Function 0 and Option 0 interchanged. Added Charge Voltage display after changing the Number of Batteries (N). Additional specifications and precautions.
V19.1	14 September 2009	Typographical corrections – Correction on screens
V20.0	18 August 2010	Program version 1460 – Changes to the following: <ul style="list-style-type: none"> • Figure 2 • 7.1 – New Views • 8.4.14 – Notes on soft start and ramping of Current
V20.1	21 August 2010	Text corrections (View-3 is View-8)
V20.2	25 August 2010	Added Option 2 and View 2; Added notes on viewing and loading of battery test profiles
V20.3	20 September 2010	Program version 1462 Minor text corrections
V20.4	1 May 2011	Corrections to Charge/Discharge Current adjustment in section 13.3
V20.5	19 May 2011	Added reference to single battery testing in section 3.10 Added charge/discharge problem statements in section 14.2
V20.6	14 July 2011	Picture Updates

Blank Page

Blank Page